

SH-5800-10-90-DP
 SH-5800-13-60-DP
 SH-5800-18-30-DP

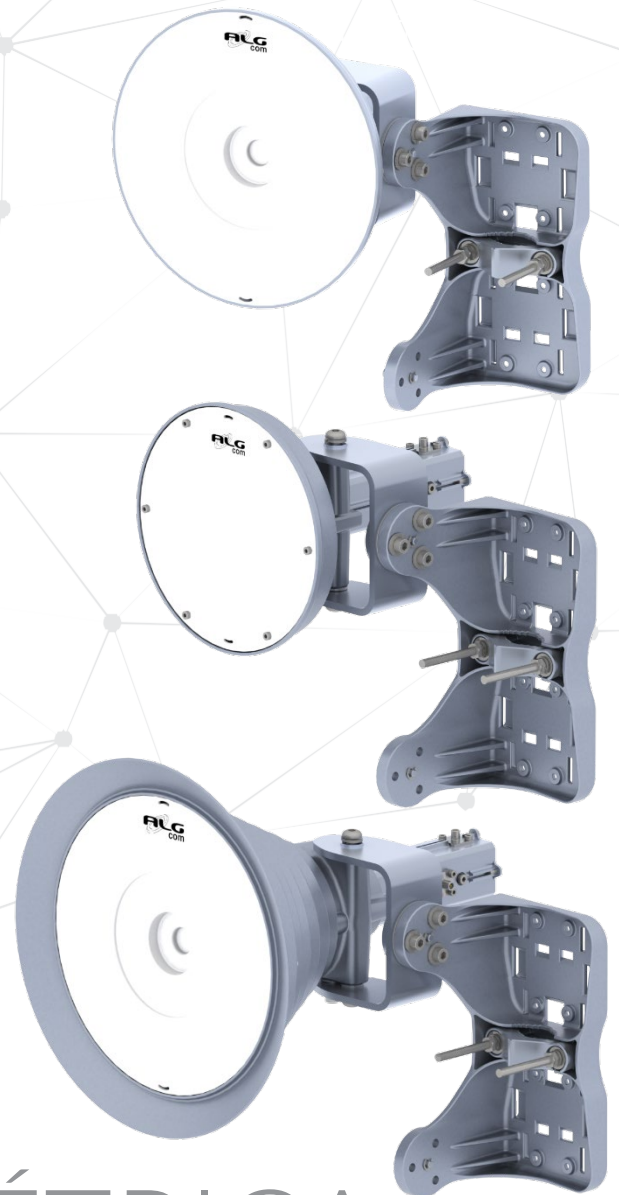

SETORIAL SIMÉTRICA

SYMMETRICAL HORN / SECTORIAL SIMETRICO

- Incrível largura de banda: 4.9 - 6.425 GHz
 Incredible bandwidth: 4.9-6.425 GHz
 Increíble rango extendido: 4.9-6.425 GHz
- Diagramas de radiação simétricos, com excelente blindagem.
 Symmetric radiation pattern with excellent isolation to noise.
 Diagrama de radiación simetrico con aislamiento excelente.
- Suporte com encaixe para diversos rádios.
 Mounting hardware ready to easily fix different radios.
 Soporte preparado para la instalación de diferentes radios.
- Fácil ajuste de azimute e elevação.
 Quick and practical azimuth and elevation adjustment.
 Rapido y conveniente ajuste de azimut y elevación.



Tecnologia para enlaces profissionais
 Technology for professional links
 Tecnología para enlaces profesionales

CARACTERÍSTICAS ELÉTRICAS

ELECTRICAL SPECIFICATIONS/CARACTERÍSTICAS ELÉCTRICAS

SH-5800-XX-XX-DP	10-90	13-60	18-30
Frequência de operação <i>Frequency range/Rango de frecuencia</i>	4.9 – 6.425 GHz		
Ganho Banda Alta <i>Gain High Band/Ganancia banda alta</i>	10.9 dBi	13.6 dBi	18.8 dBi
Ganho Banda Média <i>Gain Mid band/ Ganancia Banda media</i>	10.3 dBi	13.0 dBi	18.4 dBi
Ganho Banda Baixa <i>Gain Low band/ Ganancia Banda baja</i>	9.2 dBi	12.6 dBi	17.6 dBi
Ângulo de 6 dB <i>6 dB Beamwidth/Ângulo de 6 dB</i>	90.0°	60.0°	30.0°
Ângulo de 3 dB <i>3 dB Beamwidth/Ângulo de 6 dB</i>	61.4°	40.9°	21.3°
Relação frente-costas (165° - 180°) <i>Front-to-back ratio/Relación frente-dorso</i>	>37 dB	>40 dB	>40 dB
Isolação por polarização cruzada <i>XPD/Aislamiento por polarización cruzada</i>	>24 dB		
VSWR	1:1.8 (max) 1:1.5 (typ)		
Isolação entre portas <i>Port-to-Port Isolation/Aislamiento entre puertas</i>	>30 dB		
Polarização <i>Polarization/Polarización</i>	Dupla (V e H ou +/- 45°) Double (V and H or +/- 45°) Doble (V y H o +/- 45°)		
Conexão <i>Antenna input/Conexión</i>	N fêmea ou SMA Fêmea Reverso N female or SMA Female reverse N Hembra o SMA Hembra reverso		

CARACTERÍSTICAS MECÂNICAS

MECHANICAL SPECIFICATIONS/CARACTERÍSTICAS MECÁNICAS

SH-5800-XX-XX-DP	10-90	13-60	18-30
Ajuste de elevação <i>Elevation adjustment/Ajuste de elevación</i>	+/- 20°		
Ajuste de azimute <i>Azimuth adjustment/Ajuste de azimut</i>	+/- 20°		
Peso da antena aproximadamente <i>Approximate weight/Peso aproximado</i>	1.82 kg	2.20 kg	2.52 kg
Fixação em mastro <i>Mounting pipe diameter/Fijación en mástil</i>	Ø1"-Ø2"		
Vento operacional <i>Operational windspeed/Viento operativo</i>	110 km/h		
Vento de sobrevivência <i>Survival windspeed/Viento de supervivencia</i>	200 km/h		

-50 **DIAGRAMA DE RADIAÇÃO**

-55 **RADIATION PATTERN/DIAGRAMA DE RADIACIÓN**

Azimuth - SH-5800-10-90-DP

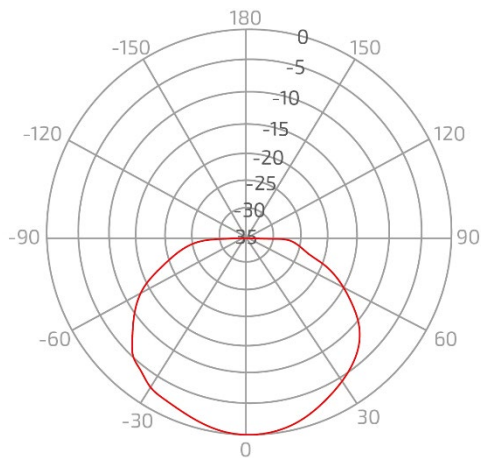

Azimuth - SH-5800-13-60-DP

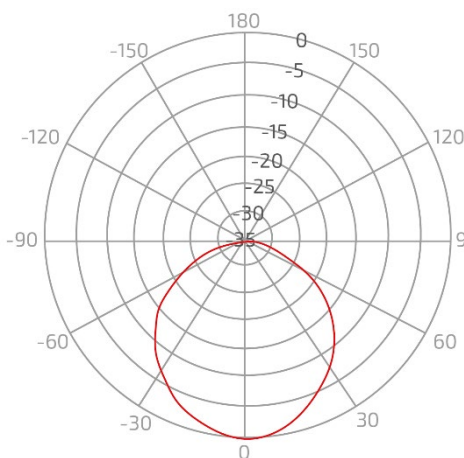

Azimuth - SH-5800-18-30-DP

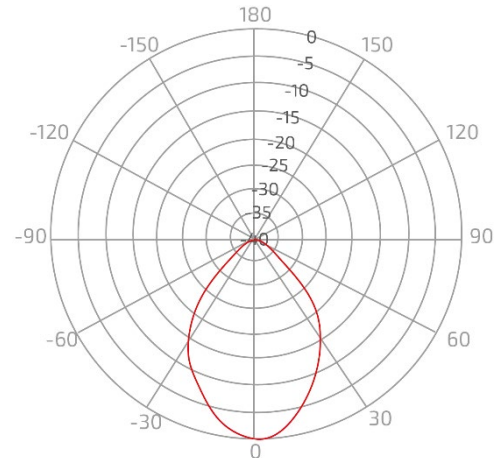

Elevation - SH-5800-10-90-DP

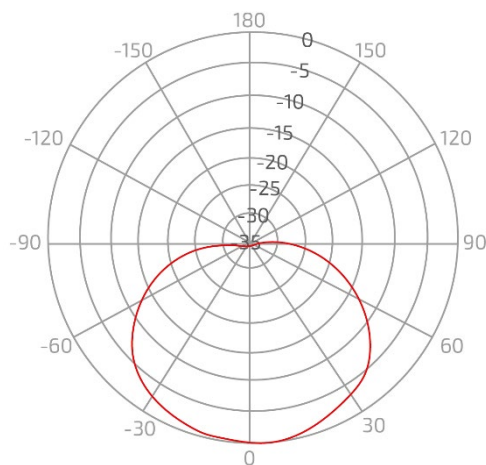

Elevation - SH-5800-13-60-DP

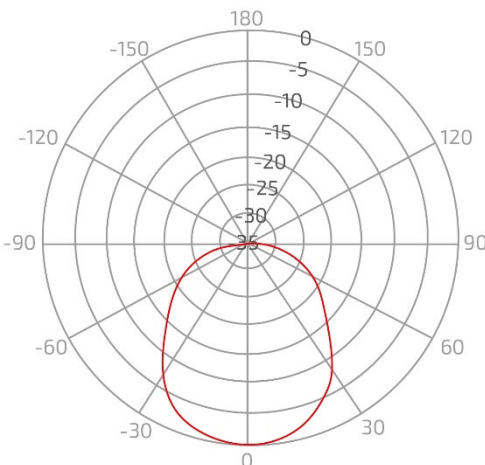

Elevation - SH-5800-18-30-DP

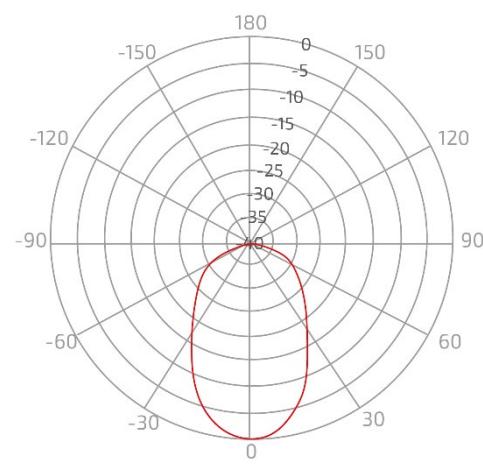

CURVA DE GANHO

GAIN OVER FREQUENCY/ GRÁFICA DE GANANCIA

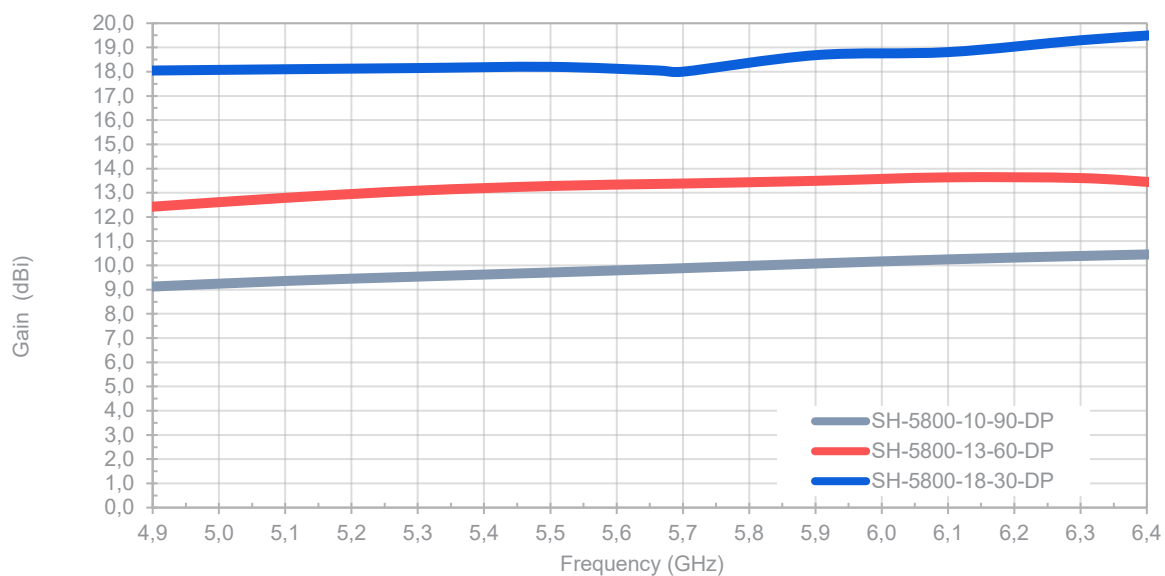

DIMENSÕES

DIMENSIONS / DIMENSIONES

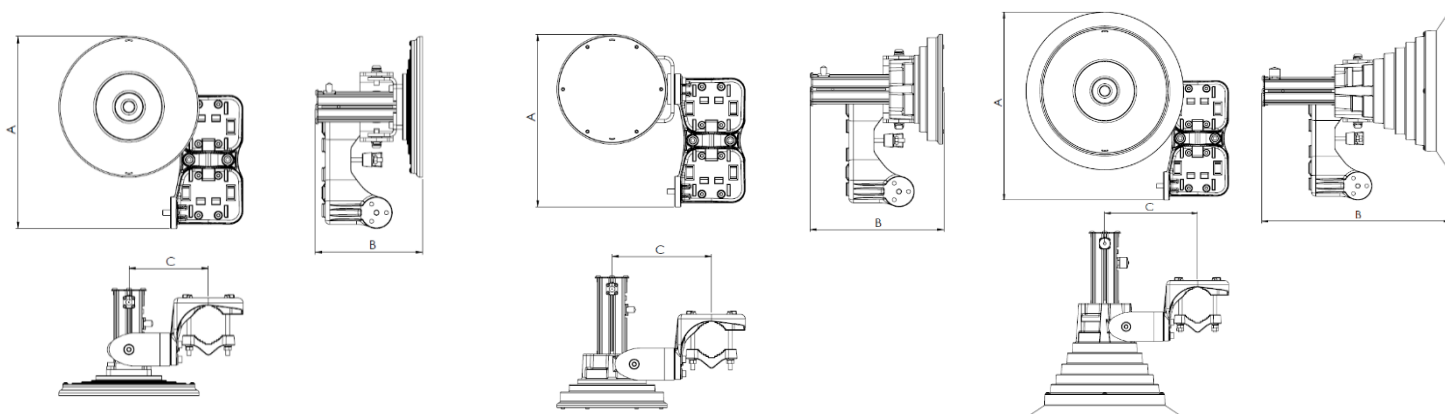

SH-5800-XX-XX-DP	10-90	13-60	18-30
A	290 mm	270 mm	317 mm
B	162 mm	209 mm	317 mm
C	120.5 mm	155 mm	157 mm

EMBALAGEM

PACKAGE / EMBALAJE

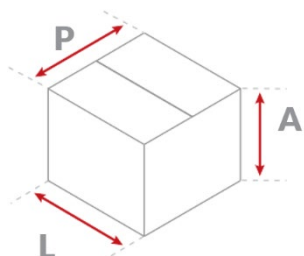

SH-5800-XX-XX-DP	10-90	13-60	18-30
L	198 mm	198 mm	400 mm
P	343 mm	343 mm	345 mm
A	324 mm	324 mm	330 mm
Peso embalado Packed weight/Peso embalado	2.45kg	2.48 kg	3.15 kg
Material Material/Material	Papalão/Cardboard/Cartón		



Tecnologia para enlaces profissionais
Technology for professional links
Tecnología para enlaces profesionales

Transformando ideias em futuro
Transforming ideas into future
Transformando ideas en futuro

+55 54 3201.1903 | algcom@algcom.com.br

Ernesto Zanrosso, 3440 | Caxias do Sul - RS | Brasil | www.algcom.com.br

